

INSTRUCTION FOR INSTALLATION OF WALK IN BATHTUB (170X75X90)

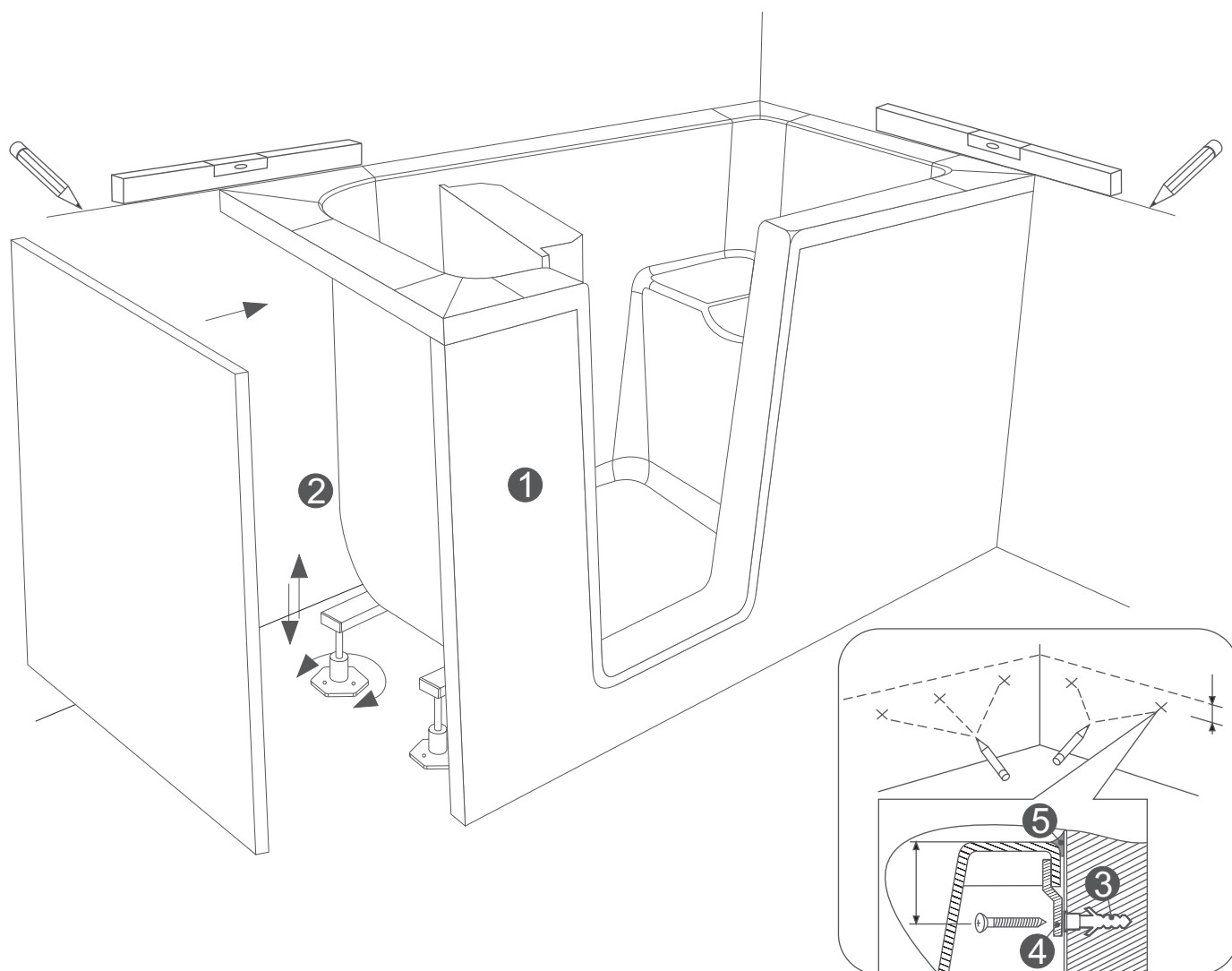

Order of installation:

- 1- First remove frontal and side panels from the palette and then unscrew and remove the bolts by which the bathtub is fixed to the palette through adjustable feet.
- 2- Place the bathtub on desired place and level the bathtub using the level device and adjustable feet ! pay attention that the panel can return.
- 3- When the bathtub is levelled, mark the upper edge of the bathtub on the wall and the line lower for 60mm parallelly.
- 4- Mark the places for setting of s-plates so that on the longer side there be 3 pieces and on the shorter 2 pieces, drill holes $\text{R } 8\text{mm}$ for bolts (3) and s-plate (4).
- 5- Return the bathtub on desired place and close permanently upper edge of the bathtub which is in contact with the wall with sanitary silicone (5).
- 6- When the bathtub is placed on desired place, perform final fine adjusting of hinges on the door, and the same is required during all movements of the bathtub.

Note: During the opening of the door, siphon lid should be in lower position ! closed..

INSTRUCTION FOR ADJUSTING OF DOOR HINGES

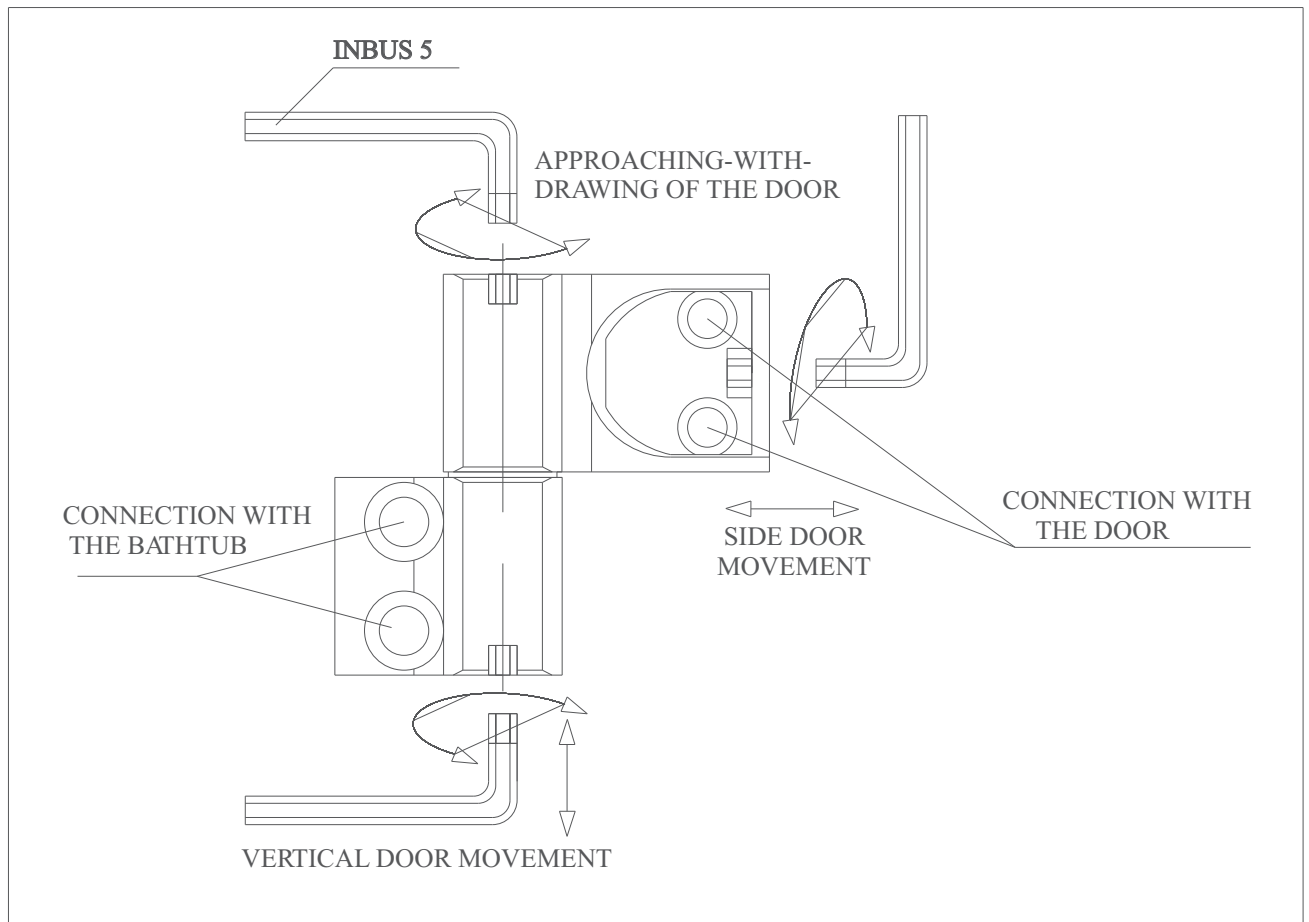

INSTRUCTION FOR BATHTUB MAINTENANCE

After bathing, wash the bathtub surface with water and clean with wet cloth.

1. Do not use rough cleaning liquids.
2. For thorough cleaning from time to time, a few drops of cleaning liquids should be put on bathtub surface and rubbed with dry soft cloth. Stronger dirty spots should be removed by hot water and mild cleaning liquid or soapsuds.
3. Remove stone layers with water or vinegar. During usage of cleaning liquids for drainage, keep to the instructions for usage of that product.
4. Deep scratches or fire stains on shiny or opaque surface are to be removed with fine sandpaper (number 1500) or metal cleaners of fine steel wool. Go carefully over the damaged bathtub surface with sandpaper or steel cleaner, in great spans in one direction. Only with shiny surface, polish it with special polish paste after removal of the damage.